



Wheel hubs (small)
(brake disc shaped) X2
小径輪軸心(ブレーキディスク型)



Rear upright X2
後軸吊り



Steel CVD universal shaft 38.5 X2
鋼製CVD軸心 38.5



Wheel axle X2
鋼製軸心



2X22 Shaft X2
鋼製軸心



4.8 Ball connector L X2
4.8ボールコネクタ

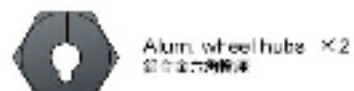

Alum. wheel hubs X2
鋁合金輪軸心



Brake calipers X2
ブレーキキャリパー

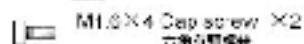

M1.6X4 Cap screw X2
六角ナット

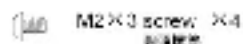

M2X3 screw X4
六角ネジ

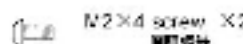

M2X4 screw X2
六角ネジ

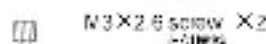

M3X2.6 screw X2
六角ネジ

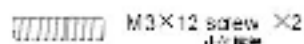

M3X12 screw X2
六角ネジ

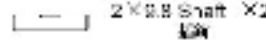

2X9.8 Shaft X2
鋼製軸心

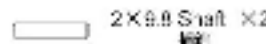

2X9.8 Shaft X2
鋼製軸心

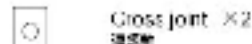

Cross joint X2
十字軸

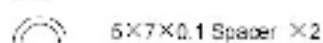

5X7X0.1 Spacer X2
スペーサー



5X10 Ball bearing X4
ボールベアリング

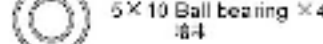

5X10 Ball bearing X4
ボールベアリング

STEP 1 Rear axle assembly

後軸組立

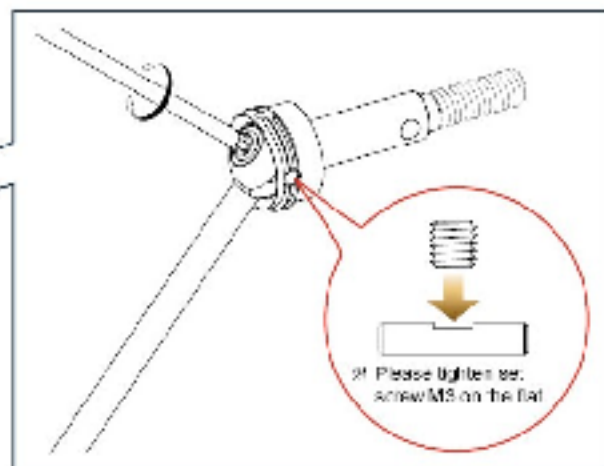
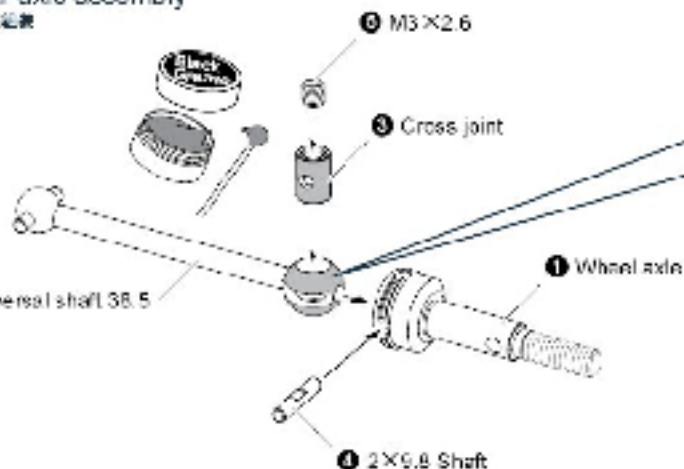
X2
Make 2

STEP 2

R

